

TECHNICKÝ LIST

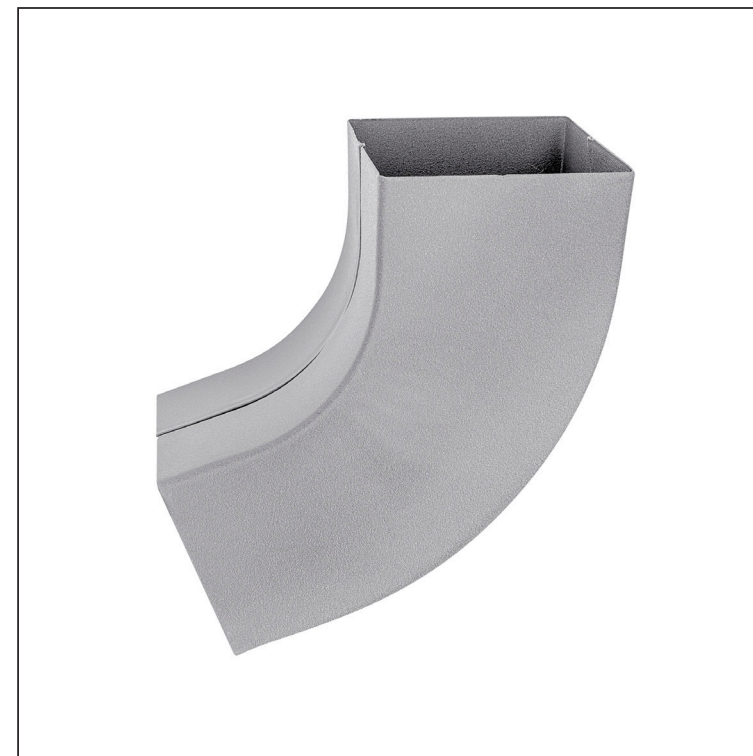

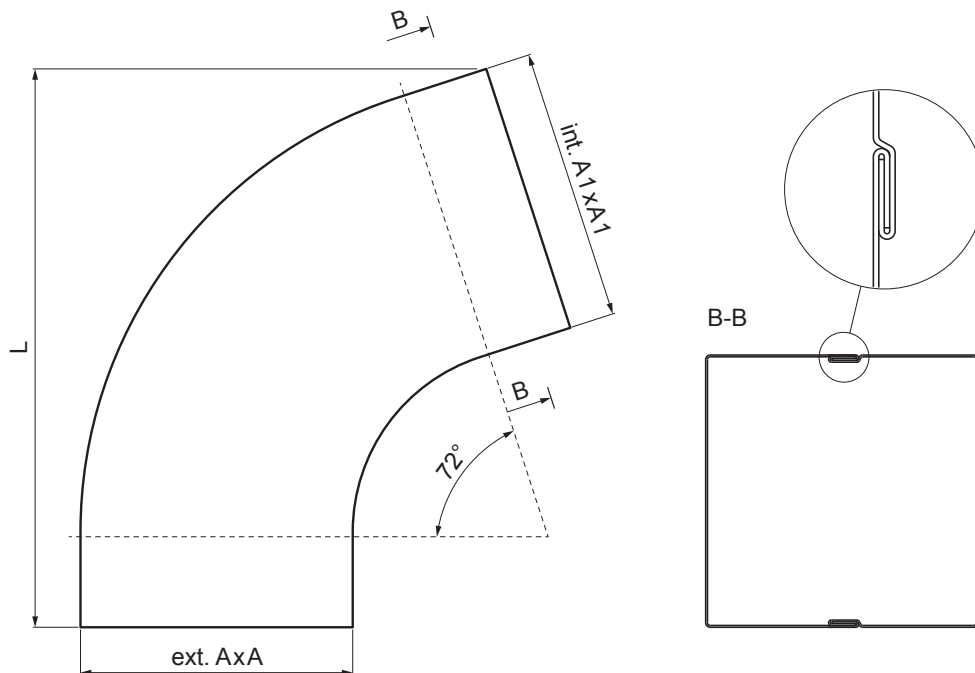

# SVODOVÉ KOLENO HRANATÉ 72°

## W.15H-WKH



**BHM** Hliník lakovaný W.15 – Bílo hliníková W.15 – RAL 9006

Rozměry [mm]			
Jmenovitá velikost	AxA	A1xA1	L
80/80	78 x 78	83 x 83	210
100/100	98 x 98	103 x 103	270

INDEX	ZMĚNA	DATUM	PODPIS	  
ZN. MAT.				
ROZM.-POLOT		T.O.	HMOTNOST kg	MER.
POM. ZAŘ.			STN	TR.Č.
VYPR. Ing. Kluska M.			POZN.	Č.POZICE
PRESK.			STARÝ V.	Č.V.
TECHNOL.	TECHNOL.		STÁRÝ V.	Č.V.
NÁZEV	Svodové koleno hranaté 72°		Počet listů	W.15H-WKH List 

Vytvořeno: 22.04.2026 17:08:43

Technické změny vyhrazeny



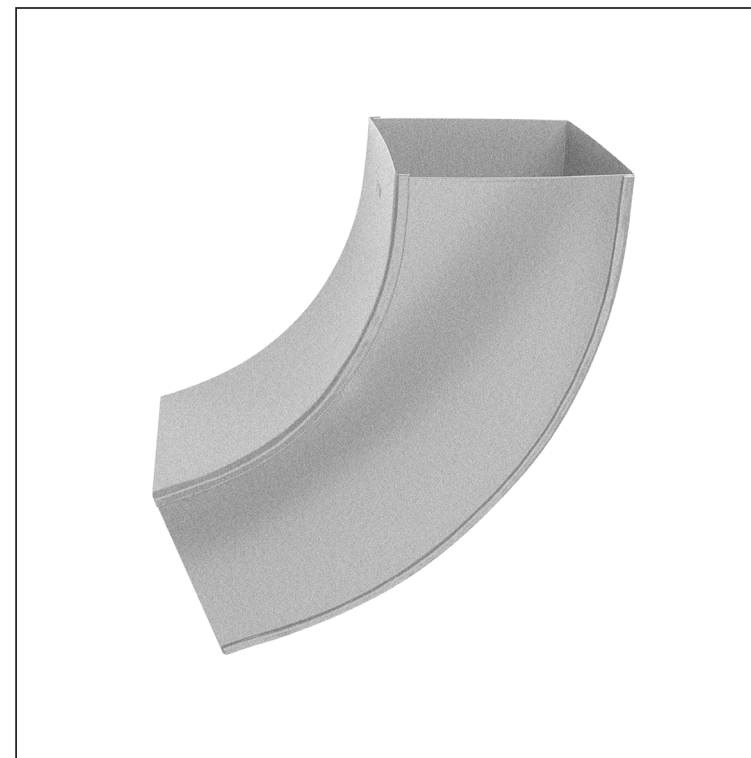
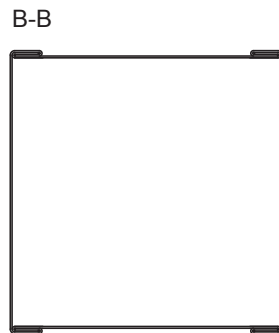

TECHNICKÝ LIST

# SVODOVÉ KOLENO HRANATÉ 72°

## W.15H-WKH



**BHM** Hliník lakovaný W.15 – Bílo hliníková W.15 – RAL 9006

INDEX	ZMĚNA	DATUM	PODPIS				
ZN. MAT.							T.O.
ROZM.–POLOT							
POM. ZAŘ.					STN		TR.Č.
VYPR.	Ing. Kluska M.				POZN.		Č.POZICE
PRESK.							
TECHNOL.		TECHNOL.			STARÝ V.		Č.V.
NÁZEV	Svodové koleno hranaté 72°				Počet listů	W.15H-WKH	List 

Vytvořeno: 22.04.2026 17:08:43

Technické změny vyhrazeny

Rozměry [mm]			
Jmenovitá velikost	AxA	A1xA1	L
120/120	118 x 118	123 x 123	300