

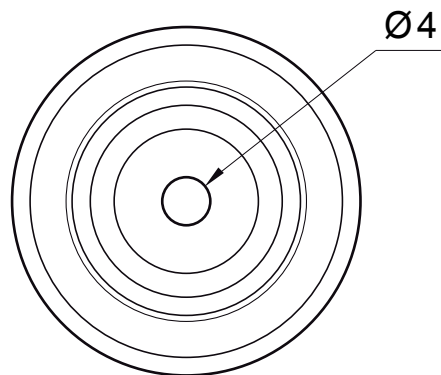

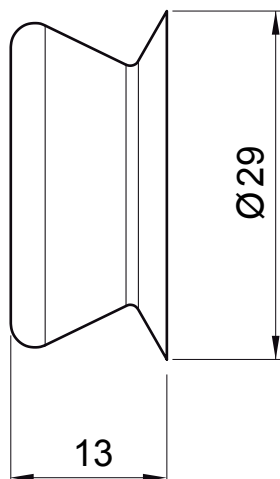

TECHNICKÝ LIST

# KRYTKA PRO ŠROUB OBJÍMKY

# P-POB-HT AKG



**TM** PVC – Testa di Moro – RAL 8028

INDEX	ZMĚNA	DATUM	PODPIS			
ZN. MAT.			T.O.			
ROZM.-POLOT					STN	TR.Č.
POM. ZAŘ.					POZN.	Č.POZICE
VYPR.	Ing. Kluska M.				STARÝ V.	Č.V.
PRESK.						
TECHNOL.	TECHNOL.					
NÁZEV	Krytka pro šroub objímky			Počet listů	P-POB-HT AKG List 	

Vytvořeno: 04.06.2026 10:35:54

Technické změny vyhrazeny

TECHNICKÝ LIST

# KRYTKA PRO ŠROUB OBJÍMKY

## P-POB-HT AKG

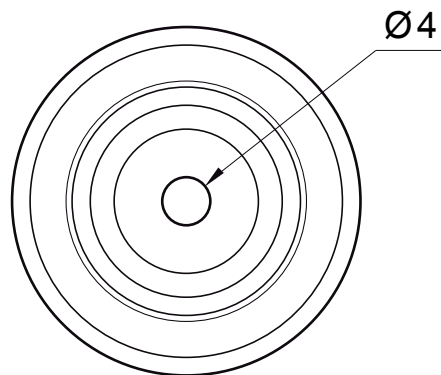
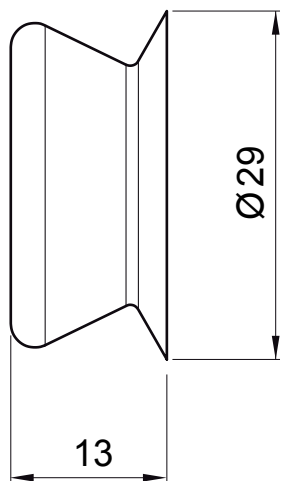

**AN** PVC – Antracit – RAL 7016

INDEX	ZMĚNA	DATUM	PODPIS	<b>KJG</b> QUALITY®	Scan code for 3D model		
ZN. MAT.						T.O.	HMOTNOST kg
ROZM.–POLOT							
POM. ZAŘ.					STN		TR.Č.
VYPR.	Ing. Kluska M.				POZN.		Č.POZICE
PRESK.							
TECHNOL.		TECHNOL.			STARÝ V.		Č.V.
NÁZEV	Krytka pro šroub objímky			Počet listů	P-POB-HT AKG		List

Vytvořeno: 04.06.2026 10:35:54

Technické změny vyhrazeny



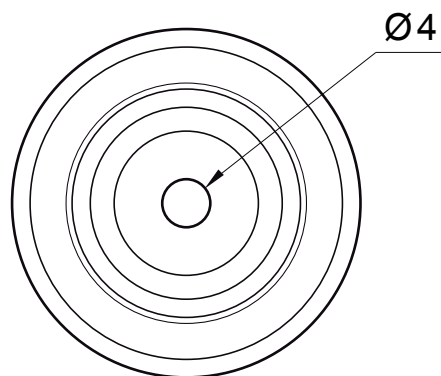
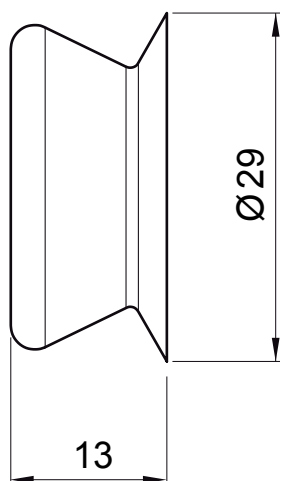

TECHNICKÝ LIST

# KRYTKA PRO ŠROUB OBJÍMKY

## P-POB-HT AKG



**IC** PVC – Intenzivní černá – RAL 9005

INDEX	ZMĚNA	DATUM	PODPIS			
ZN. MAT.		T.O.	HMOTNOST kg			
ROZM.–POLOT				STN	TR.Č.	
POM. ZAŘ.				POZN.	Č.POZICE	
VYPR. Ing. Kluska M.				STARÝ V.	Č.V.	
PRESK.						
TECHNOL.	TECHNOL.					
NÁZEV	Krytka pro šroub objímky			Počet listů	P-POB-HT AKG	List 

Vytvořeno: 04.06.2026 10:35:54

Technické změny vyhrazeny



TECHNICKÝ LIST

# KRYTKA PRO ŠROUB OBJÍMKY

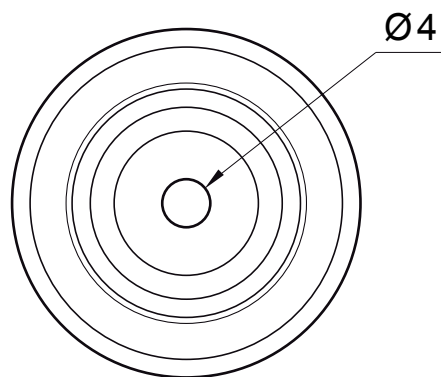
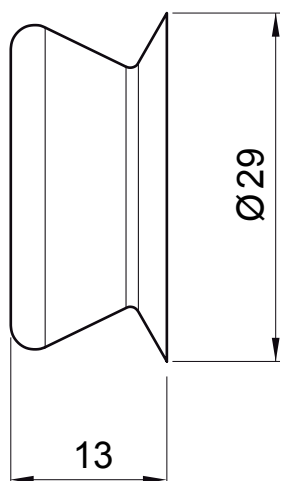
## P-POB-HT AKG



**OC** PVC – Ocelově červená – RAL 3009

INDEX	ZMĚNA	DATUM	PODPIS				
ZN. MAT.						T.O.	HMOTNOST kg
ROZM.–POLOT							
POM. ZAŘ.					STN		TR.Č.
VYPR.	Ing. Kluska M.				POZN.		Č.POZICE
PRESK.							
TECHNOL.		TECHNOL.			STARÝ V.		Č.V.
NÁZEV	Krytka pro šroub objímky				Počet listů	P-POB-HT AKG	
						List	

Vytvořeno: 04.06.2026 10:35:54

Technické změny vyhrazeny



TECHNICKÝ LIST

# KRYTKA PRO ŠROUB OBJÍMKY

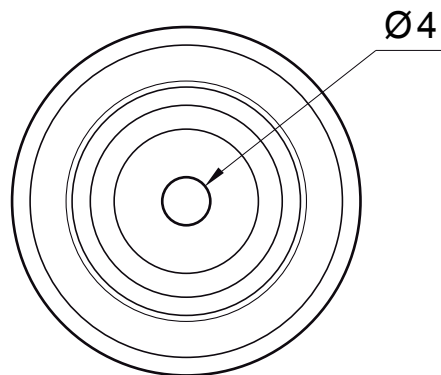
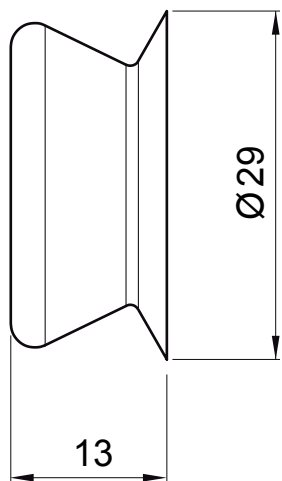
## P-POB-HT AKG



**MH** PVC – Měděno hnědá – RAL 8004

INDEX	ZMĚNA	DATUM	PODPIS				
ZN. MAT.						T.O.	HMOTNOST kg
ROZM.-POLOT							
POM. ZAŘ.					STN		TR.Č.
VYPR.	Ing. Kluska M.				POZN.		Č.POZICE
PRESK.							
TECHNOL.		TECHNOL.			STARÝ V.		Č.V.
NÁZEV	Krytka pro šroub objímky				Počet listů	P-POB-HT AKG	
						List	

Vytvořeno: 04.06.2026 10:35:54

Technické změny vyhrazeny

TECHNICKÝ LIST

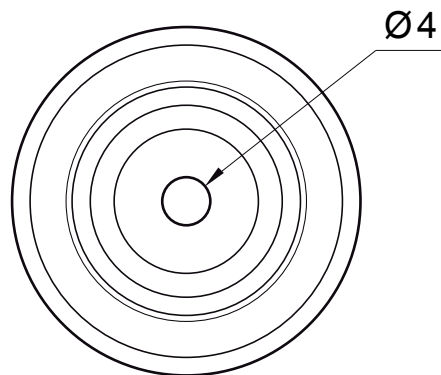
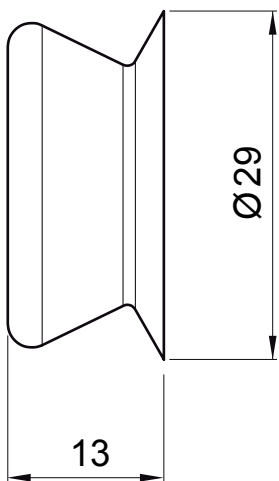

# KRYTKA PRO ŠROUB OBJÍMKY

## P-POB-HT AKG



**B** PVC – Bílá  
RAL 9010

**SB** PVC – Šedo bílá  
RAL 9002

INDEX	ZMĚNA	DATUM	PODPIS		
ZN. MAT.		T.O.	HMOTNOST kg		
ROZM.–POLOT				STN	TR.Č.
POM. ZAŘ.				POZN.	Č.POZICE
VYPR. Ing. Kluska M.				STARÝ V.	Č.V.
PRESK.					
TECHNOL.	TECHNOL.				
NÁZEV	Krytka pro šroub objímky			Počet listů	P-POB-HT AKG List 

Vytvořeno: 04.06.2026 10:35:54

Technické změny vyhrazeny

TECHNICKÝ LIST

# KRYTKA PRO ŠROUB OBJÍMKY



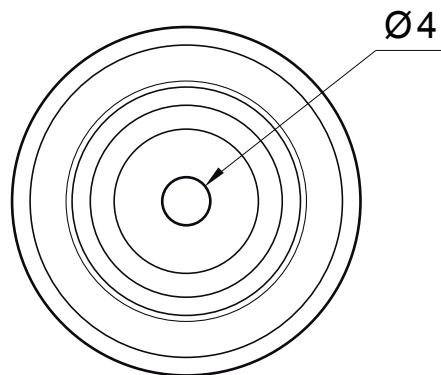
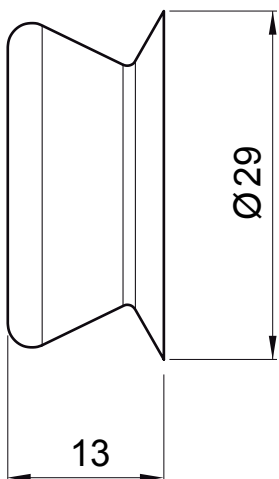

## P-POB-HT AKG



**PS** PVC – Prachově šedá  
RAL 7037

**BH** PVC – Bílo hliníková  
RAL 9006

**BHT** PVC – Bílo hliníková tmavá  
RAL 9007

INDEX	ZMĚNA	DATUM	PODPIS			
ZN. MAT.		T.O.	HMOTNOST kg			
ROZM.–POLOT				STN	TR.Č.	
POM. ZAŘ.				POZN.	Č.POZICE	
VYPR. Ing. Kluska M.				STARÝ V.	Č.V.	
PRESK.						
TECHNOL.	TECHNOL.					
NÁZEV	Krytka pro šroub objímky			Počet listů	P-POB-HT AKG	List 

Vytvořeno: 04.06.2026 10:35:54

Technické změny vyhrazeny



TECHNICKÝ LIST

# KRYTKA PRO ŠROUB OBJÍMKY

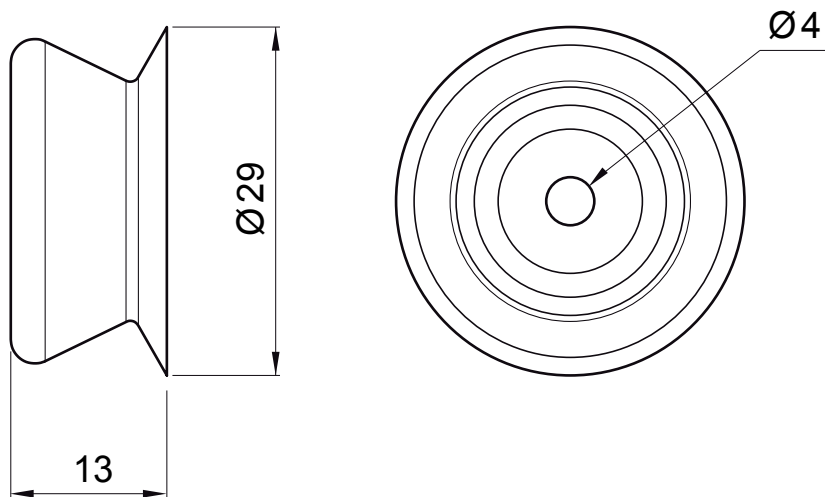
## P-POB-HT AKG



**MZ** PVC – Mechově zelená – RAL 6005

INDEX	ZMĚNA	DATUM	PODPIS				
ZN. MAT.						T.O.	HMOTNOST kg
ROZM.–POLOT							
POM. ZAŘ.					STN		TR.Č.
VYPR.	Ing. Kluska M.				POZN.		Č.POZICE
PRESK.							
TECHNOL.		TECHNOL.			STARÝ V.		Č.V.
NÁZEV	Krytka pro šroub objímky				Počet listů	P-POB-HT AKG	
						List	

Vytvořeno: 04.06.2026 10:35:54

Technické změny vyhrazeny



TECHNICKÝ LIST

# KRYTKA PRO ŠROUB OBJÍMKY

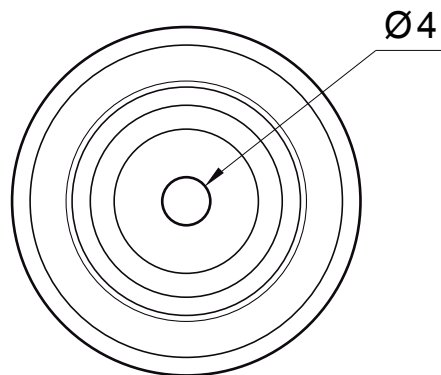
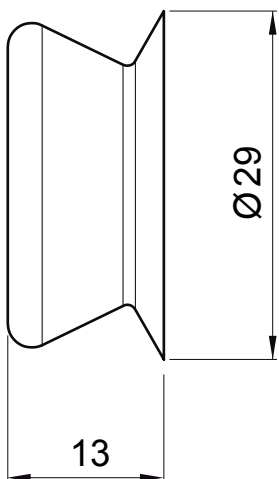
## P-POB-HT AKG



**ZH** PVC – Zeleno hnědá – RAL 7013

INDEX	ZMĚNA	DATUM	PODPIS				
ZN. MAT.						T.O.	HMOTNOST kg
ROZM.–POLOT							
POM. ZAŘ.					STN		TR.Č.
VYPR.	Ing. Kluska M.				POZN.		Č.POZICE
PRESK.							
TECHNOL.		TECHNOL.			STARÝ V.		Č.V.
NÁZEV	Krytka pro šroub objímky				Počet listů	P-POB-HT AKG	
						List	

Vytvořeno: 04.06.2026 10:35:54

Technické změny vyhrazeny