

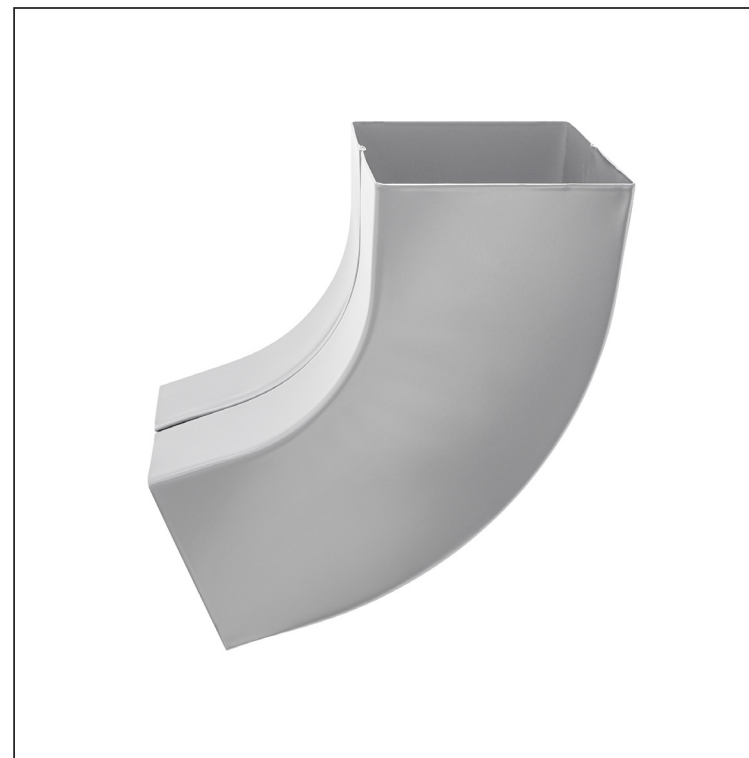



TECHNICKÝ LIST

SVODOVÉ KOLENO HRANATÉ 72°

WH-WKH



BH Hliník lakovaný – Bílo hliníková – RAL 9006

INDEX	ZMĚNA	DATUM	PODPIS				
ZN. MAT.							T.O.
ROZM.-POLOT						STN	TR.Č.
POM. ZAŘ.						POZN.	Č.POZICE
VYPR.	Ing. Kluska M.					STARÝ V.	Č.V.
PRESK.							
TECHNOL.		TECHNOL.					
NÁZEV	Svodové koleno hranaté 72°				Počet listů	WH-WKH	List 

Vytvořeno: 07.06.2026 12:49:11

Technické změny vyhrazeny

Rozměry [mm]			
Jmenovitá velikost	AxA	A1xA1	L
80/80	78 x 78	83 x 83	210
100/100	98 x 98	103 x 103	270



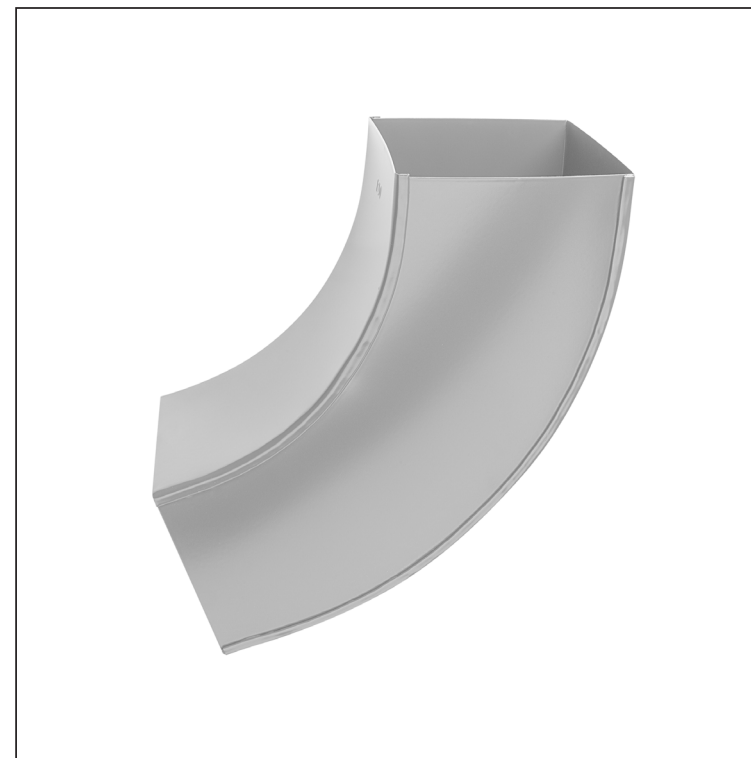

TECHNICKÝ LIST

SVODOVÉ KOLENO HRANATÉ 72°

WH-WKH



BH Hliník lakovaný – Bílo hliníková – RAL 9006

INDEX	ZMĚNA	DATUM	PODPIS				
ZN. MAT.							T.O.
ROZM.-POLOT							
POM. ZAŘ.					STN		TR.Č.
VYPR.	Ing. Kluska M.				POZN.		Č.POZICE
PRESK.							
TECHNOL.		TECHNOL.			STARÝ V.		Č.V.
NÁZEV	Svodové koleno hranaté 72°				Počet listů	WH-WKH	List 

Vytvořeno: 07.06.2026 12:49:11

Technické změny vyhrazeny

Rozměry [mm]			
Jmenovitá velikost	AxA	A1xA1	L
120/120	118 x 118	123 x 123	300