

TECHNICKÝ LIST

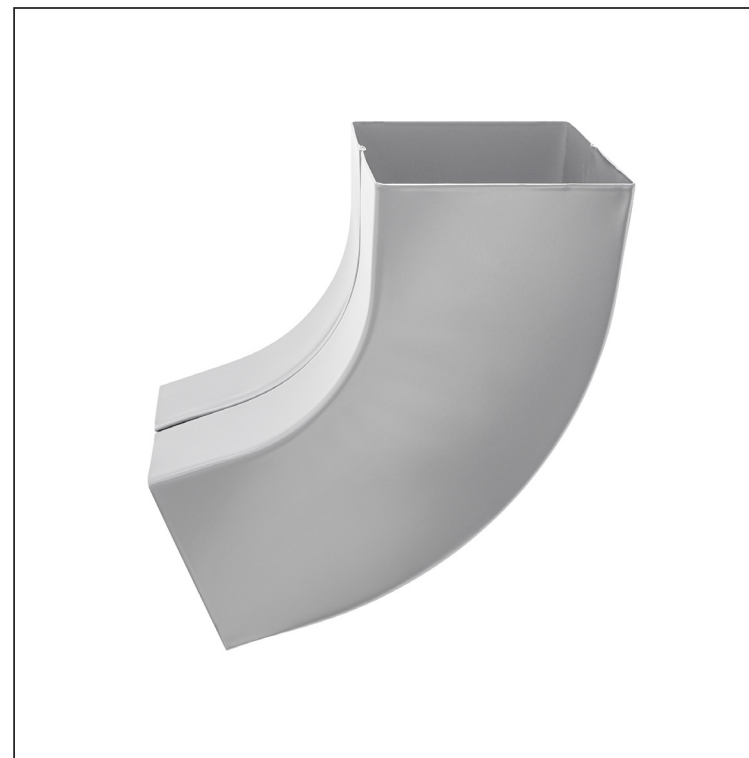



# SVODOVÉ KOLENO HRANATÉ 72°

## PH-PKH



**BH** Pozink lakovaný – Bílo hliníková – RAL 9006

| Rozměry [mm]       |         |           |     |
|--------------------|---------|-----------|-----|
| Jmenovitá velikost | AxA     | A1xA1     | L   |
| 80/80              | 78 x 78 | 83 x 83   | 210 |
| 100/100            | 98 x 98 | 103 x 103 | 270 |

|             |                            |          |        |   |   |   |  |
|-------------|----------------------------|----------|--------|---|---|---|--|
| INDEX       | ZMĚNA                      | DATUM    | PODPIS |  |  |  |  |
| ZN. MAT.    |                            |          |        |   |   |   | T.O.   |
| ROZM.-POLOT |                            |          |        |   |   | STN   | TR.Č.  |
| POM. ZAŘ.   |                            |          |        |   |   | POZN.   | Č.POZICE   |
| VYPR.       | Ing. Kluska M.             |          |        |   |   | STARÝ V.  | Č.V.   |
| PRESK.      |                            |          |        |   |   |   |  |
| TECHNOL.    |                            | TECHNOL. |        |   |   |   |  |
| NÁZEV       | Svodové koleno hranaté 72° |          |        |   | Počet listů   | PH-PKH  | List  |

Vytvořeno: 21.04.2026 03:44:04

Technické změny vyhrazeny

TECHNICKÝ LIST

# SVODOVÉ KOLENO HRANATÉ 72°

## PH-PKH

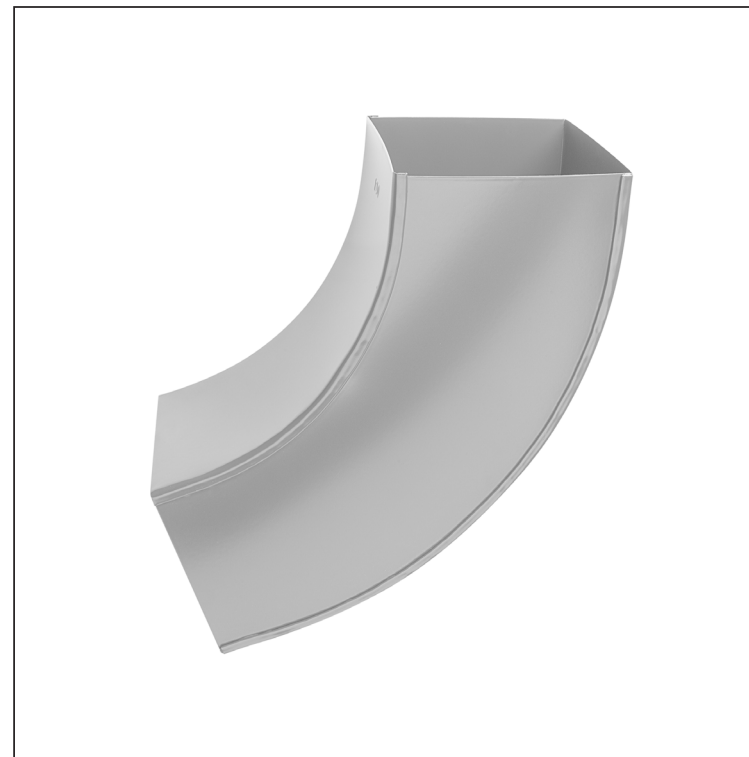

**BH** Pozink lakovaný – Bílo hliníková – RAL 9006

| Rozměry [mm]       |           |           |     |
|--------------------|-----------|-----------|-----|
| Jmenovitá velikost | AxA       | A1xA1     | L   |
| 120/120            | 118 x 118 | 123 x 123 | 300 |
| 150/150            | 148 x 148 | 153 x 153 | 350 |

|                      |                            |       |        |             |             |
|----------------------|----------------------------|-------|--------|-------------|-------------|
| INDEX                | ZMĚNA                      | DATUM | PODPIS |             |             |
| ZN. MAT.             |                            |       |        |             |             |
| ROZM.–POLOT          |                            | T.O.  |        | HMOTNOST kg | MER.        |
| POM. ZAŘ.            |                            |       |        | STN         | TR.Č.       |
| VYPR. Ing. Kluska M. |                            |       |        | POZN.       | Č.POZICE    |
| PRESK.               |                            |       |        | STARÝ V.    | Č.V.        |
| TECHNOL.             | TECHNOL.                   |       |        |             |             |
| NÁZEV                | Svodové koleno hranaté 72° |       |        | Počet listů | PH-PKH List |

Vytvořeno: 21.04.2026 03:44:04

Technické změny vyhrazeny