

TECHNICKÝ LIST

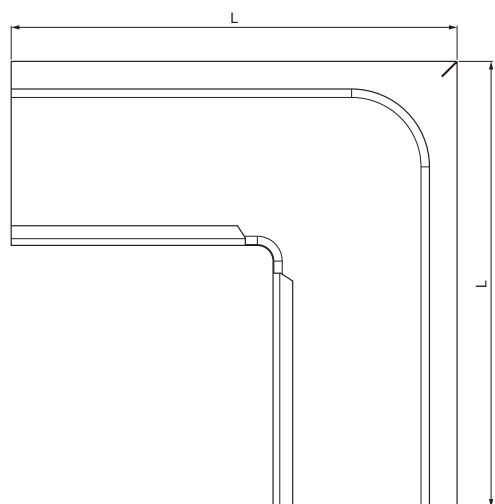

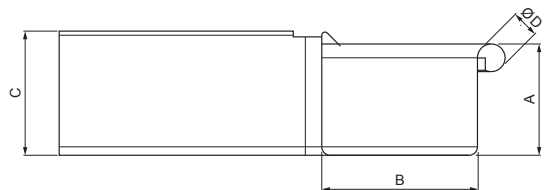

ROH VNĚJŠÍ HRANATÝ

PH-PRAH



BH Pozink lakovaný – Bílo hliníková – RAL 9006

Rozměry [mm]					
Jmenovitá velikost	A	B	C	ØD	L
200	42	70	50	16	250
250	55	85	65	18	300
333	75	120	85	20	300

INDEX	ZMĚNA	DATUM	PODPIS	  		
ZN. MAT.					T.O.	HMOTNOST kg
ROZM.-POLOT					STN	TR.Č.
POM. ZAŘ.					POZN.	Č.POZICE
VYPR. Ing. Kluska M.					STARÝ V.	Č.V.
PRESK.						
TECHNOL.	TECHNOL.					
NÁZEV	Roh vnější hranatý				Počet listů	PH-PRAH
						List 

Vytvořeno: 20.01.2026 07:39:07

Technické změny vyhrazeny

TECHNICKÝ LIST



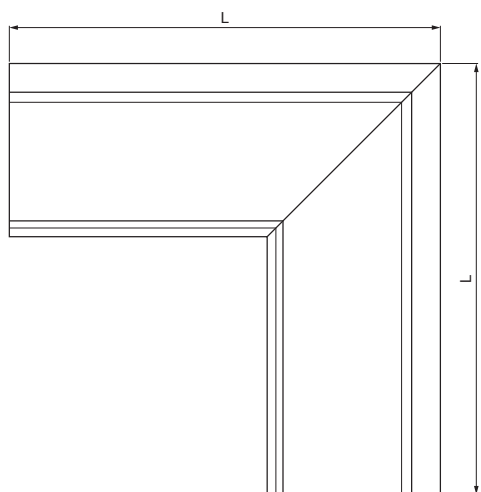
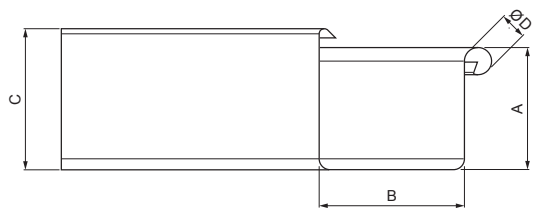

ROH VNĚJŠÍ HRANATÝ

PH-PRAH



BH Pozink lakovaný – Bílo hliníková – RAL 9006

Rozměry [mm]					
Jmenovitá velikost	A	B	C	ØD	L
400	90	150	100	22	400
500	110	200	121	22	400

INDEX	ZMĚNA	DATUM	PODPIS			
ZN. MAT.						
ROZM.-POLOT						
POM. ZAŘ.					STN	TR.Č.
VYPR.	Ing. Kluska M.				POZN.	Č.POZICE
PRESK.						
TECHNOL.		TECHNOL.			STARÝ V.	Č.V.
NÁZEV	Roh vnější hranatý				Počet listů	PH-PRAH
						List 

Vytvořeno: 20.01.2026 07:39:07

Technické změny vyhrazeny