





TECHNICKÝ LIST

# SVODOVÉ KOLENO HRANATÉ 72°

## PH-PKH



**USS** Pozink – U. S. Steel

INDEX	ZMĚNA	DATUM	PODPIS				
ZN. MAT.							T.O.
ROZM.–POLOT							
POM. ZAŘ.					STN		TR.Č.
VYPR.	Ing. Kluska M.				POZN.		Č.POZICE
PRESK.							
TECHNOL.		TECHNOL.			STARÝ V.		Č.V.
NÁZEV	Svodové koleno hranaté 72°				Počet listů	PH-PKH	List 

Vytvořeno: 22.04.2026 09:35:37

Technické změny vyhrazeny

Rozměry [mm]			
Jmenovitá velikost	AxA	A1xA1	L
80/80	78 x 78	83 x 83	210
100/100	98 x 98	103 x 103	270



TECHNICKÝ LIST

# SVODOVÉ KOLENO HRANATÉ 72°

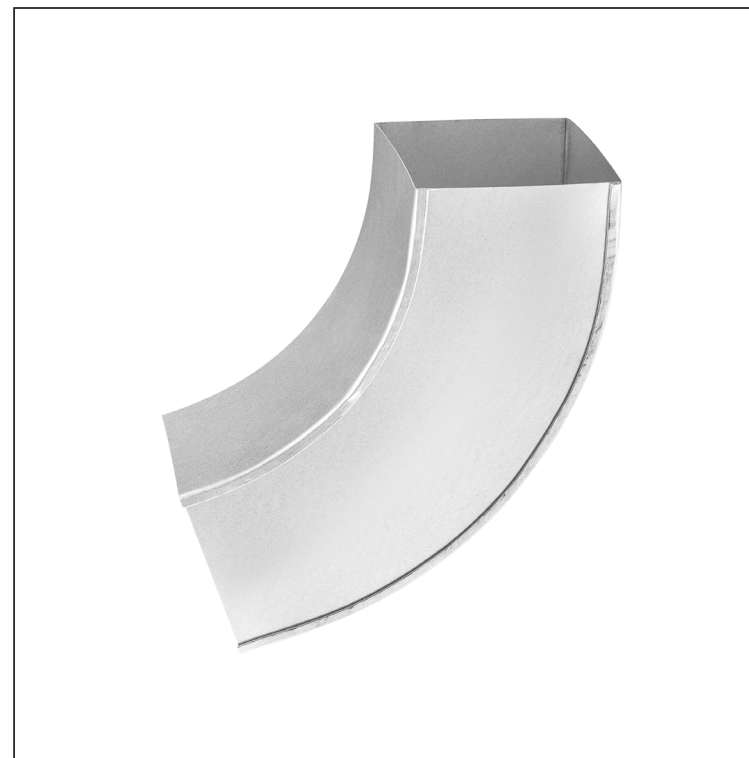
## PH-PKH



**USS** Pozink – U. S. Steel

INDEX	ZMĚNA	DATUM	PODPIS				
ZN. MAT.						T.O.	HMOTNOST kg
ROZM.–POLOT						STN	TR.Č.
POM. ZAŘ.						POZN.	Č.POZICE
VYPR.	Ing. Kluska M.					STARÝ V.	Č.V.
PRESK.							
TECHNOL.		TECHNOL.					
NÁZEV	Svodové koleno hranaté 72°				Počet listů	PH-PKH	List 

Rozměry [mm]			
Jmenovitá velikost	AxA	A1xA1	L
120/120	118 x 118	123 x 123	300
150/150	148 x 148	153 x 153	350

Vytvořeno: 22.04.2026 09:35:37

Technické změny vyhrazeny